

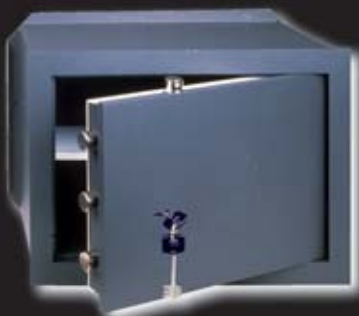

CISA



S.P.S.



Cassaforre CISA da murare 1 stella a chiave

- Frontale monoblocco in acciaio spessore mm. 8 con taglio laser tra cornice e sportello.
- Catenacci in acciaio nichelato del diametro di mm. 22.
- Assemblaggio dei componenti di tenuta con saldature robotizzate.
- Speciale verniciatura a forno ad alta resistenza contro la corrosione.
- Piastra di protezione della serratura in acciaio carbonitrurato.
- Serratura e meccanismi fissati direttamente allo sportello.
- In dotazione 1 ripiano, istruzioni d'installazione e foglio istruzioni.
- Due chiavi in ottone nichelato.



8A010

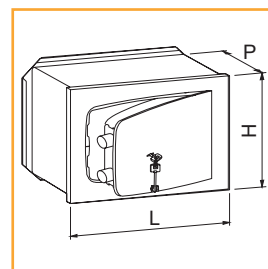

Codice SPS	Articolo	L mm.	H mm.	P mm.	Luce porta mm.	Catenacci	Kg	UM	EAN
SCI8A010.20.0	8A010 20	310	190	145	192-115	2	9,4	PZ	8 015345 507550
SCI8A010.21.0	8A010 21	310	190	195	192-115	2	10,3	PZ	8 015345 507567
SCI8A010.30.0	8A010 30	360	240	145	242-165	2	12,65	PZ	8 015345 507574
SCI8A010.31.0	8A010 31	360	240	195	242-165	2	13,65	PZ	8 015345 507581
SCI8A010.40.0	8A010 40	420	300	195	302-225	2	18,1	PZ	8 015345 507598
SCI8A010.41.0	8A010 41	420	300	245	302-225	2	20	PZ	8 015345 507604

Cassaforte CISA da murare a chiave

- Frontale in acciaio spessore mm. 10 (mm. 12 per dimensioni 420 x 550 e 490 x 620).
- Assemblaggio dei componenti di tenuta con saldature robotizzate.
- Catenacci in acciaio nichelato del diametro di 22 mm.
- Speciale verniciatura a forno ad alta resistenza contro la corrosione.
- Piastra di protezione della serratura in acciaio carbonitrurato.
- Serratura e meccanismi fissati direttamente sullo sportello della cassaforte.
- Comandi di apertura, non sporgenti, in posizione di riposo.
- Ripiani (dove previsto)
- Foglio istruzioni.
- Istruzioni d'installazione.
- Due chiavi in ottone nichelato.

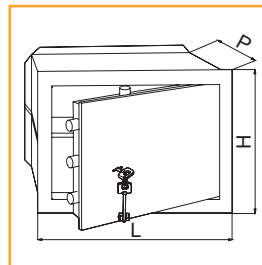

82010

Codice SPS	Articolo	L mm.	H mm.	P mm.	Luce porta mm.	Catenacci	Kg	UM	EAN
SCI82010/10	82010 10	260	170	150	142-95	2	8,5	PZ	8 015345 170495
SCI82010/20	82010 20	310	190	150	192-115	2	10,8	PZ	8 015345 170518
SCI82010/21	82010 21	310	190	200	192-115	2	11,45	PZ	8 015345 170525
SCI82010/30	82010 30	360	240	150	242-165	2	14,55	PZ	8 015345 170549
SCI82010/31	82010 31	360	240	200	242-165	2	15,2	PZ	8 015345 170556
SCI82010/32	82010 32	360	240	250	242-165	2	16,3	PZ	8 015345 170563
SCI82010/40	82010 40	420	300	200	302-225	2+3	21,2	PZ	8 015345 170570
SCI82010/41	82010 41	420	300	250	302-225	2+3	22,8	PZ	8 015345 170587
SCI82010/42	82010 42	420	300	300	302-225	2+3	24,6	PZ	8 015345 170594
SCI82010/50	82010 50	490	360	200	372-285	2+3	28,6	PZ	8 015345 170600
SCI82010/51	82010 51	490	360	250	372-285	2+3	29,75	PZ	8 015345 170617
SCI82010/52	82010 52	490	360	300	372-285	2+3	31,3	PZ	8 015345 170624
SCI82010/70	82010 70	360	490	200	242-415	2+3	29,1	PZ	8 015345 170662
SCI82010/71	82010 71	360	490	250	242-415	2+3	30,4	PZ	8 015345 170679
SCI82010/80	82010 80	420	550	200	302-475	2+3	39,45	PZ	8 015345 112549
SCI82010/81	82010 81	420	550	250	302-475	2+3	41	PZ	8 015345 112563
SCI82010/90	82010 90	490	620	200	372-545	2+3	50,30	PZ	8 015345 112563
SCI82010/91	82010 91	490	620	250	372-545	2+3	52,40	PZ	8 015345 112570
SCI82010/92	82010 92	490	620	300	372-545	2+3	54,60	PZ	8 015345 170716

Cassaforte CISA da murare

- . A triplo combinatore meccanico.
- . Frontale in acciaio spessore mm 10.
- . Assemblaggio dei componenti di tenuta con robuste saldature.
- . Catenacci in acciaio nichelato del diametro di 22 mm.
- . Speciale verniciatura a forno ad alta resistenza contro la corrosione.
- . Piastra di protezione della serratura in acciaio carbonitrurato.
- . Serratura e meccanismi fissati direttamente sullo sportello della cassaforte.
- . Comandi di apertura, non sporgenti, in posizione di riposo.
- . Ripiani (pz. 1)
- . Foglio istruzioni.
- . Istruzioni d' installazione.



82410

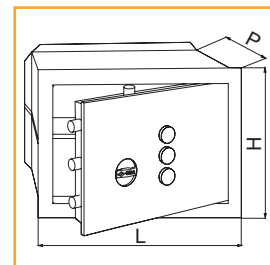

Codice SPS	Articolo	L mm.	H mm.	P mm.	Luce porta mm.	Catenacci	Kg	UM	EAN
SCI82410.20	82410 20	310	190	150	192-115	2	10,8	PZ	8 015345 171256
SCI82410.21	82410 21	310	190	200	192-115	2	11,7	PZ	8 015345 171263
SCI82410.30	82410 30	360	240	150	242-165	2	14,7	PZ	8 015345 171270
SCI82410/31	82410 31	360	240	200	242-165	2	15,8	PZ	8 015345 171287
SCI82410.32	82410 32	360	240	250	242-165	2	17,3	PZ	8 015345 112891
SCI82410/40	82410 40	420	300	200	302-225	5	22	PZ	8 015345 171294
SCI82410.41	82410 41	420	300	250	302-225	5	23,2	PZ	8 015345 112907
SCI82410.50	82410 50	490	360	200	372-285	5	29	PZ	8 015345 171317

Cassaforre CISA da murare

- . Triplo combinatore meccanico.
- . Frontale in acciaio spessore mm 10.
- . Assemblaggio dei componenti di tenuta con robuste saldature.
- . Catenacci in acciaio nichelato del diametro di 22 mm.
- . Speciale verniciatura a forno ad alta resistenza contro la corrosione.
- . Piastra di protezione della serratura in acciaio carbonitrurato.
- . Serratura e meccanismi fissati direttamente sullo sportello della cassaforte.
- . Comandi di apertura, non sporgenti, in posizione di riposo.
- . Ripiani (pz. 1)
- . Foglio istruzioni.
- . Istruzioni d'installazione.
- . Due chiavi in ottone nichelato.

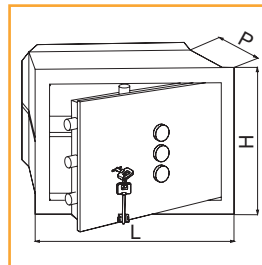

82210

Codice SPS	Articolo	L mm.	H mm.	P mm.	Luce porta mm.	Catenacci	Kg	UM	EAN
SCI82210.20	82210 20	310	190	150	192-115	2	11	PZ	
SCI82210.21	82210 21	310	190	200	192-115	2	11,9	PZ	
SCI82210.30	82210 30	360	240	150	242-165	2	15	PZ	
SCI82210/31	82210 31	360	240	200	242-165	2	15,85	PZ	
SCI82210.40	82210 40	420	300	200	302-225	5	22,2	PZ	









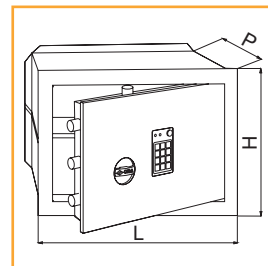



Cassaforte CISA da murare

- . A combinazione elettronica Vision.
- . Tastiera elettroluminescente.
- . Frontale in acciaio spessore mm 10.
- . Assemblaggio dei componenti di tenuta con robuste saldature.
- . Catenacci in acciaio nichelato del diametro di 22 mm.
- . Speciale verniciatura a forno ad alta resistenza contro la corrosione.
- . Piastra di protezione della serratura in acciaio carbonitrurato.
- . Serratura e meccanismi fissati direttamente sullo sportello della cassaforte.
- . Comandi di apertura, non sporgenti, in posizione di riposo.
- . Cavo per alimentazione esterna d' emergenza.
- . Ripiani (dove previsto)
- . Foglio istruzioni.
- . Istruzioni d' installazione.
- . Combinatore elettronico.
- . Luce interna.
- . Anta smontabile.
- . Alimentazione con pile stilo-alcaline da 1,5 V.
- . Segnalazioni acustiche e visive.
- . Blocco antimanipolazione.



82710



Codice SPS	Articolo	L mm.	H mm.	P mm.	Luce porta mm.	Catenacci	Kg	UM	EAN
SCI82710/30	82710 30	360	240	150	242-165	2	14,4	PZ	
SCI82710/31	82710 31	360	240	200	242-165	2	15,4	PZ	
SCI82710/32	82710 32	360	240	250	242-165	2	16,7	PZ	
SCI82710/40	82710 40	420	300	200	302-225	5	21,6	PZ	
SCI82710/41	82710 41	420	300	250	302-225	5	23,10	PZ	
SCI82710/42	82710 42	420	300	300	302-225	5	24,9	PZ	
SCI82710/50	82710 50	490	360	200	372-285	5	28,95	PZ	
SCI82710/51	82710 51	490	360	250	372-285	5	30	PZ	
SCI82710/52	82710 52	490	360	300	372-285	5	31,75	PZ	
SCI82710/70	82710 70	360	490	200	242-415	5	29,35	PZ	
SCI82710/71	82710 71	360	490	250	242-415	5	31	PZ	
SCI82710/72	82710 72	360	490	300	242-415	5	32,7	PZ	

Cassaforte CISA da mobile 1 stella a chiave

- . Frontale monoblocco in acciaio spessore 8 mm.
- . Assemblaggio dei componenti di tenuta con saldature robotizzate.
- . Catenacci in acciaio nichelato diametro 22 mm.
- . Piastra di protezione della serratura in acciaio carbonitrurato.
- . Speciale verniciatura a forno ad alta resistenza contro la corrosione.
- . Serratura e meccanismi fissati direttamente allo sportello.
- . In dotazione ripiani interni (pz.1), istruzioni d'uso e installazione, tasselli per il fissaggio (pz.4).
- . Due chiavi in ottone nichelato.

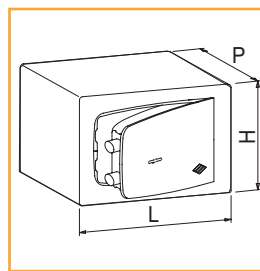

Codice SPS

Articolo

L
mm.H
mm.P
mm.Luce porta
mm.

Catenacci

Kg

UM

EAN

SCI8A050.23.0

8A050 23 0

310

190

250

242-165

2

13,2

PZ



8A050

Cassaforte CISA da mobile a chiave

- . Frontale in acciaio spessore mm 10 (mm. 12 per dimensioni 420 x 550 e 490 x 620)..
- . Pareti laterali e superiori in acciaio spessore 5 mm.
- . Assemblaggio dei componenti di tenuta con robuste saldature.
- . Catenacci in acciaio nichelato del diametro di 22 mm.
- . Speciale verniciatura a forno ad alta resistenza contro la corrosione.
- . Piastra di protezione della serratura in acciaio carbonitrurato.
- . Serratura e meccanismi fissati direttamente sullo sportello della cassaforte.
- . Comandi di apertura, non sporgenti, in posizione di riposo.
- . Ripiani (dove previsto).
- . Tasselli per il fissaggio (pz. 4).
- . Foglio istruzioni.
- . Istruzioni d'installazione.
- . Due chiavi in ottone nichelato.

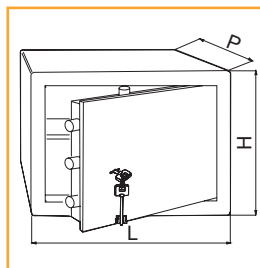

Codice SPS

Articolo

L
mm.H
mm.P
mm.Luce porta
mm.

Catenacci

Kg

UM

EAN

SCI82050/34

82050 34

360

240

300

242-165

2

28,3

PZ



SCI82050/43

82050 43

420

300

350

302-225

2+3

40,65

PZ



SCI82050/53

82050 53

490

360

350

372-285

2+3

54

PZ



SCI82050.74

82050 74

360

490

400

242-415

2+3

57

PZ



SCI82050.85

82050 85

420

550

450

302-475

2+3

75,7

PZ



SCI82050.95

82050 95

490

620

450

372-545

2+3

92

PZ



82050

Cassaforte CISA da mobile

- . A combinazione elettronica Vision.
- . Tastiera elettroluminescente.
- . Frontale in acciaio spessore mm 10.
- . Pareti laterali e superiore in acciaio spessore 5 mm.
- . Assemblaggio dei componenti di tenuta con robuste saldature.
- . Catenacci in acciaio nichelato del diametro di 22 mm.
- . Speciale verniciatura a forno ad alta resistenza contro la corrosione.
- . Piastra di protezione della serratura in acciaio carbonitrurato.
- . Serratura e meccanismi fissati direttamente sullo sportello della cassaforte.
- . Comandi di apertura, non sporgenti, in posizione di riposo.
- . Cavo per alimentazione esterna d'emergenza.
- . Ripiani (dove previsto).
- . Tasselli per il fissaggio (pz. 4).
- . Foglio istruzioni.
- . Istruzioni d'installazione.
- . Combinatore elettronico.
- . Luce interna.
- . Anta smontabile.
- . Alimentazione con pile stilo-alcaline da 1,5 V.
- . Segnalazioni acustiche e visive.
- . Blocco antimanipolazione.



82750

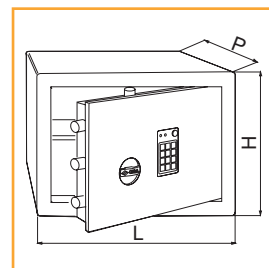

Codice SPS	Articolo	L mm.	H mm.	P mm.	Luce porta mm.	Catenacci	Kg	UM	EAN
SCI82750/34	82750 34	360	240	300	242-165	2	28,2	PZ	8 015345 671336
SCI82750/43	82750 43	420	300	350	302-225	5	40,5	PZ	8 015345 671343
SCI82750/53	82750 53	490	360	350	372-285	5	51	PZ	8 015345 671350
SCI82750/74	82750 74	360	490	400	242-415	5	55,65	PZ	8 015345 671367

Cassaforte CISA componibile da murare Darwin

- . Vano cassaforte con coperchio provvisorio
- . Componibilità frontale-vano cassaforte.
- . Assemblaggio dei componenti di tenuta con robuste saldature.
- . Speciale verniciatura a forno ad alta resistenza contro la corrosione.



83000

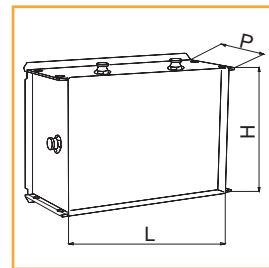

Codice SPS	Articolo	L mm.	H mm.	P mm.	Kg	UM	EAN
SCI83000.40	83000 40	470	336	200	10,65	PZ	8 015345 172307
SCI83000.41	83000 41	470	336	250	12	PZ	8 015345 172314

Cassaforse CISA componibile da murare Darwin

- . Frontale in acciaio spessore mm 10 con chiave.
- . Componibilità frontale-vano cassaforte.
- . Assemblaggio dei componenti di tenuta con robuste saldature.
- . Catenacci in acciaio nichelato del diametro di 22 mm.
- . Speciale verniciatura a forno ad alta resistenza contro la corrosione.
- . Piastra di protezione della serratura in acciaio carbonitrurato.
- . Serratura e meccanismi fissati direttamente sullo sportello della cassaforte.
- . Comandi di apertura, non sporgenti, in posizione di riposo.
- . Cornice coprifilo.
- . Ripiano.
- . Bulloni per il fissaggio al vano.
- . Foglio istruzioni, da abbinare art. 83000.40/41.
- . Istruzioni d'installazione.
- . Due chiavi in ottone nichelato.

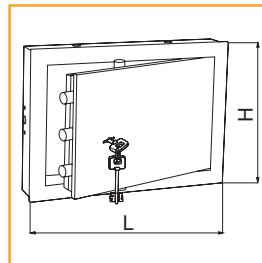
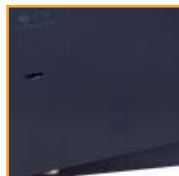

Codice SPS

Articolo

L
mm.H
mm.

Catenacci

Kg

UM

EAN

SCI83010.40

83010 40

420

300

5

17,9

PZ



83010

Cassaforse CISA componibile da murare Darwin

- . Frontale con combinatore elettronico in acciaio spessore mm 10 con luce interna.
- . Componibilità frontale-vano cassaforte.
- . Assemblaggio dei componenti di tenuta con saldature al laser.
- . Catenacci in acciaio nichelato del diametro di 22 mm.
- . Speciale verniciatura a forno ad alta resistenza contro la corrosione.
- . Piastra di protezione della serratura in acciaio carbonitrurato.
- . Alimentazione con pile stilo alcaline da 1,5 V.
- . Serratura e meccanismi fissati direttamente sullo sportello della cassaforte.
- . Comandi di apertura, non sporgenti, in posizione di riposo.
- . Cornice coprifilo.
- . Ripiano.
- . Bulloni per il fissaggio al vano.
- . Foglio istruzioni, da abbinare art. 83000.40/41.
- . Istruzioni d'installazione.
- . Cavo per alimentazione esterna.
- . Tastiera alfanumerica retroilluminata.

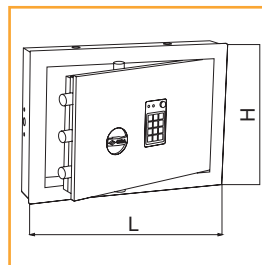

Codice SPS

Articolo

L
mm.H
mm.

Catenacci

Kg

UM

EAN

SCI83710.40

83710 40

420

300

5

18,3

PZ



83710



Armadio CISA porta fucili

- . Rastrelliera in legno capacità 6 fucili.
- . Spessore corpo e porta 3 mm.
- . Serratura di chiusura a chiave doppia mappa.
- . Predisposto per il fissaggio tramite 4 fori sulla parete posteriore.
- . Taglio laser, per ridurre lo spazio tra porta e corpo e aumentare la sua sicurezza.
- . Catenacci girevoli antitaglio.
- . Cassettino portacartucce.
- . Tesoretto interno a chiave tubolare.
- . Finitura graphite antigraffio.



84081

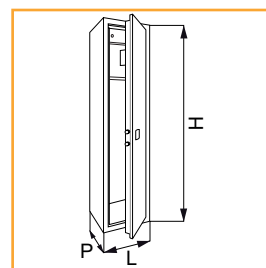
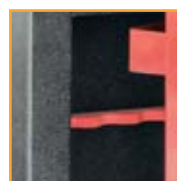
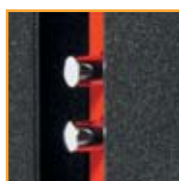

Codice SPS	Articolo	L mm.	H mm.	P mm.	Luce porta mm.	Catenacci	Kg	UM	EAN
SCI84081.06	84081.06	555	1380	205	403-1325	2	68	PZ	8 015345 813583

Cavetto CISA

- . Cavetto di alimentazione esterna per cassaforte digitale 9 V.



07430 31 0



Codice SPS	Articolo	Tensione	Kg	UM	EAN
SCI07430.31	07430 31 0	9 V	0,030	PZ	8 015345 333531

Cavetto CISA

- . Cavetto di alimentazione esterna per cassaforte digitale 6 V.



07430 32 0



Codice SPS	Articolo	Tensione	Kg	UM	EAN
SCI07430.32	07430 32 0	6 V	0,030	PZ	8 015345 544852

Set chiave di cambio

- . Per casseforti con combinatori 3 pomoli.
- . Per serie 82210 - 82410.

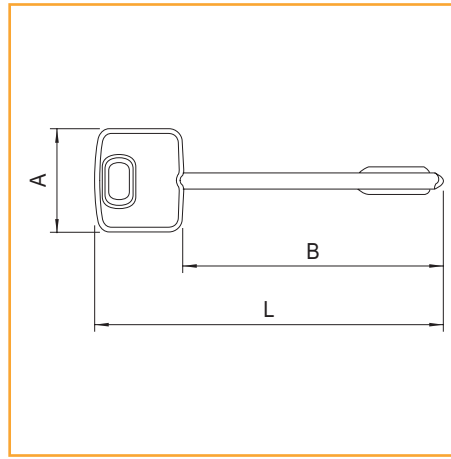
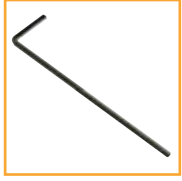

Codice SPS

Articolo

L
mm.

A
mm.

B
mm.

Finitura

Imb.

UM

EAN

SCI07109.03

07109 03 0

70

22

51

nichelata

1

PZ



07109 03

Portatile CISA

- . Portatile 9 V.
- . Per serie 82610 - 82650.



Codice SPS

Articolo

Tensione

Kg

UM

EAN

SCI07114.00

07114 00 0

9 V

0,030

PZ



07114 00

Portatile CISA

- . Portatile 6 V.
- . Per serie 82710 - 82750.



Codice SPS

Articolo

Tensione

Kg

UM

EAN

SCI07114.05

07114 05 0

6 V

0,030

PZ



07114 05 0

671



Tastiera CISA

. Tastiera per serie 82610 - 82650.



07114 08

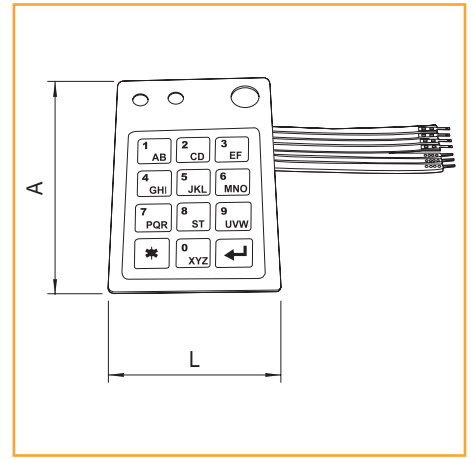

Codice SPS	Articolo	L mm.	A mm.	Per serie	Imb. UM	EAN
SCI07114.08	07114 08 0	52	87	82610 - 82650	1 PZ	8 015345 544869

Scheda elettronica CISA

. Per casseforti Digit Vision (82710 - 82750).

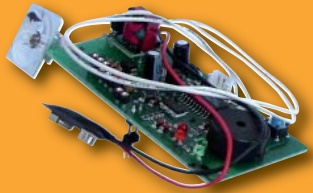

07114 15

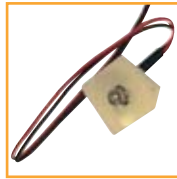

Codice SPS	Articolo	Per casseforti	Kg UM	EAN
SCI07114.15	07114 15 0	Digit Vision	0,035 PZ	8 015345 687214

Tastiera CISA

. Per casseforti Digit Vision (82710 - 82750).



07114 16

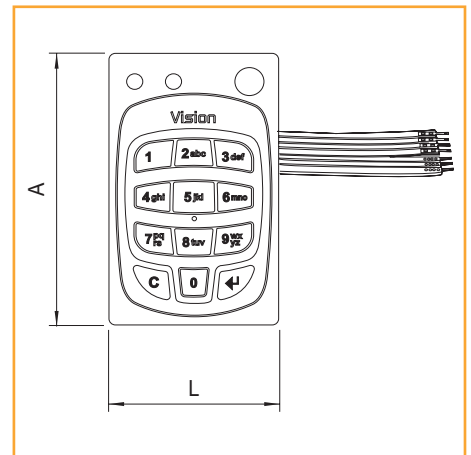

Codice SPS	Articolo	L mm.	A mm.	Per casseforti	Imb. UM	EAN
SCI07114.16	07114 16 0	52	87	82710-82750	1 PZ	8 015345 687245

Kit di conversione CISA

. Da casseforti Digit a casseforti Digit Vision 6 V.



Codice SPS

Articolo

Per casseforti

Kg

UM

EAN

SCI07114.17

07114 17

Digit e Digit Vision

0,370

PZ

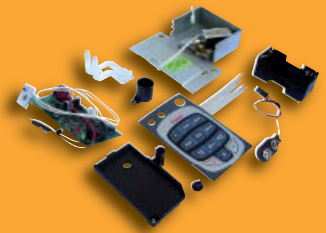

07114 17

Serratura CISA per casseforti

- . Serratura in acciaio con rivestimento in zinco.
- . Un punto di chiusura.
- . Due chiavi a doppia mappa.
- . Per casseforti a chiave o a chiave e combinatori meccanici: serie 82010.20÷32 - 82050.34 - 82210.20÷31.

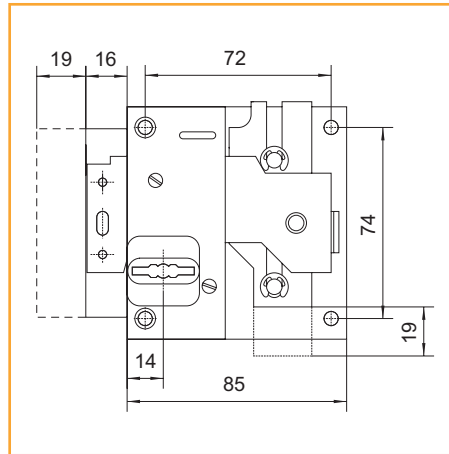
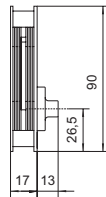

57411 30

Codice SPS

Articolo

Punti di chiusura

Finitura

Imb. UM

EAN

SCI57411.30

57411 30 1

1

zincata

1

PZ



Serratura CISA per casseforti

- . Serratura in acciaio con rivestimento in zinco.
- . Tre punti di chiusura.
- . Due chiavi a doppia mappa.
- . Per casseforti a chiave o chiave e combinatori meccanici: serie 82010.40÷92 - 82050.43÷95 - 82210.40 - 83010.40.

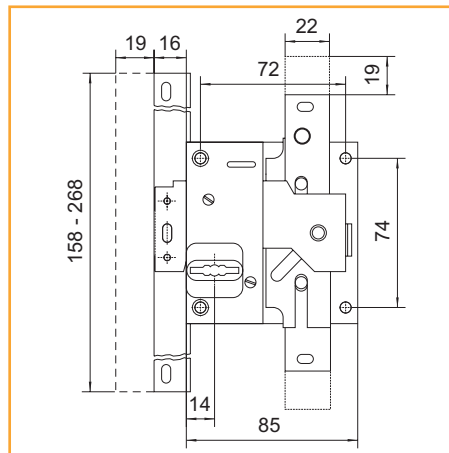
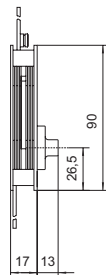

57416 30

Codice SPS

Articolo

Punti di chiusura

Finitura

Imb. UM

EAN

SCI57416.30

57416 30 1

3

zincata

1

PZ



673